

B1310



IMPERX: Technically superior products, full tech support, rapid-response customer care. “Bobcat 2.0” adds many new features, lens control, more memory and enhanced image quality. Each easy to use Bobcat is supported by IMPERX professionals.

INTERFACES AVAILABLE:

Resolution
Sensor
Sensor Format

Pixel Size
Frame Rate Standard Clock
Frame Rate Overclocked
Maximum Frame Rate
Minimum S/N Ratio
Output Format

Analog Gain Control
Black Level Control
Digital Gain and Offset
RGB Gain and Offset
White Balance
Shutter Speed
Exposure Control
Long Integration
Regions of Interest (ROI)
Binning H/V
Trigger Inputs

Trigger Options

Trigger Modes

Double Trigger (PIV) Interframe
External Inputs/Outputs
Strobe Output
RS232 Interface
Pulse Generator
Image Overlay
Image Enhancement

Internal DDR Memory
On Board FIFO (GEV & PoE)
Gamma Correction
Data Corrections

Minimum Illumination
Lens Mount
Video Iris Control
Iris, Zoom Focus Control
Supply Input Range
Power Consumption
Size – Width/Height
Size – Length

Weight
Vibration, Shock
Environmental
Humidity
MTBF
Regulatory

Camera Link® Base (PoCL), GigE Vision, PoE, CoaXPress
1280 x 960 (std.), 1296 x 966 (max.)
ICX-445 EXview HAD CCD
4.86mm (H) x 3.62mm (V) 6.0mm diagonal,
1/3” optical format
3.75 µm
40 MHz / 26 fps
64 MHz / 39 fps
191 fps
60dB
Mono CCD: 8, 10, 12, 14-bit (Single only)
Color CCD: 8, 10, 12, RGB 24
Manual, Auto: 0 - 36dB 1024 steps
Manual, 1024 steps
Manual
Manual
Manual, auto, off
1µs/step, 1/200,000 to 1/26 sec (nom)
Manual, auto, external
Up to 16 seconds
7 ROIs, any line to any line, any pixel to any pixel
1x, 2x, 3x, 4x, 8x (Independent for H & V)
External (TTL via IN1/IN2), pulse generator, software, computer
Level, edge, pulse width, internal exposure, up to 16 seconds trigger delay, debounce
Free-run, standard, double, fast, asynchronous, frame accumulation
Time: 200 nanoseconds
2 IN, 2 OUT, user programmable
2 strobes, programmable position and duration
Yes, programmable
Yes, programmable
Optical center, programmable H & V lines
Threshold, contrast enhancement, knee correction, horizontal flip, negative image, bit shift (+/- 7 places)
2Gb (256 MB)
1Gb (128 MB)
G=1.0, G=0.45, user upgradeable LUT
Defective/hot pixel correction (static, dynamic), black level, vertical smear
0.5 Lux, F/1.4
C-Mount (Default), CS
Auto, programmable
Manual, user programmable
12VDC (10V - 15V), 1.5 A inrush
CLB 2.0 W, GEV 3.4W, PoE 4.5W, CXP TBD
46mm (W) x 46mm (H) – Applies to all interfaces
CLB 46.8mm (L), GEV 64.7mm (L), PoE 78.3mm (L), CXP 54.5mm (L)
CLB 160g, GEV 246g, PoE 348g, CXP 237g
100g (20-200) HZ XYZ, 1000g
-40°C to +85°C Operating, -50°C to +90°C Storage
10% to 90% non-condensing
>660,000 hours @ 40°C (Telcordia SR-332)
FCC 15 part A, CE, RoHS

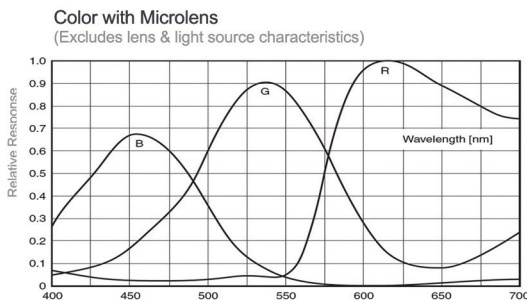
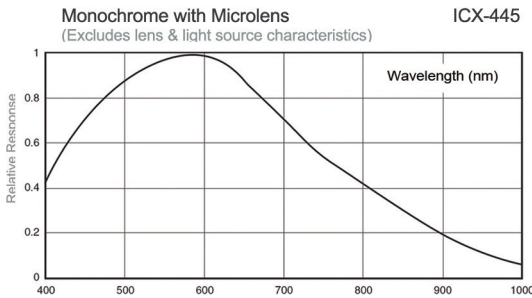

BOBCAT 2.0 B1310 Specifications

GigE Vision(Without PoE)

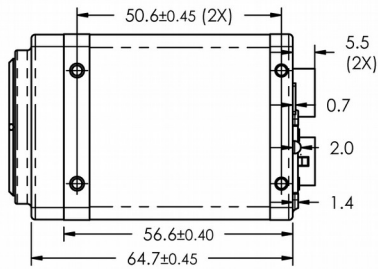

GigE Vision(With PoE)

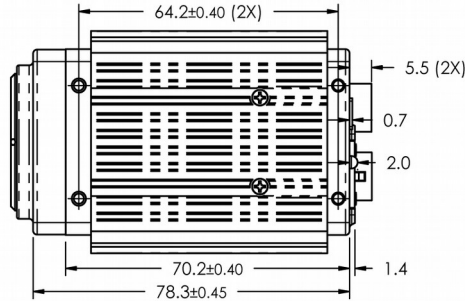

Camera Link

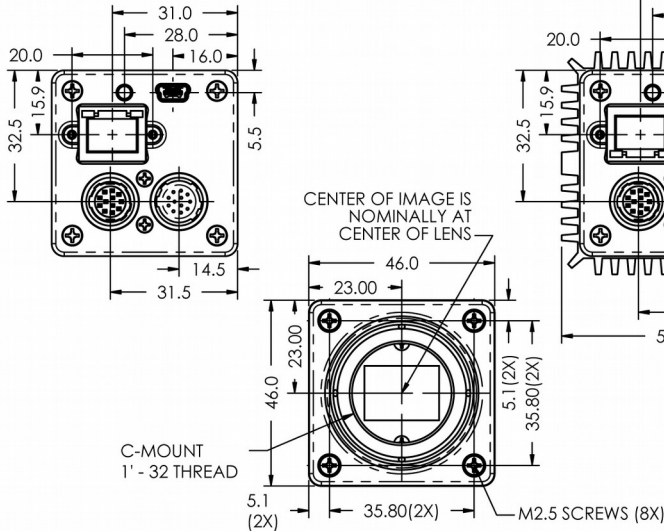
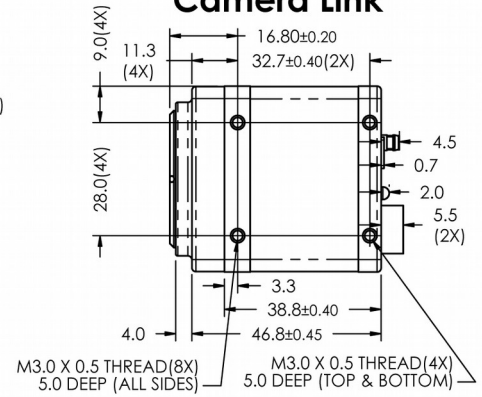

COMMON FRONT VIEW

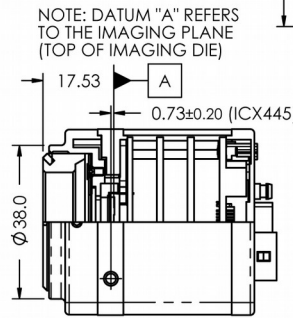

COMMON IMAGE PLANE DISTANCE

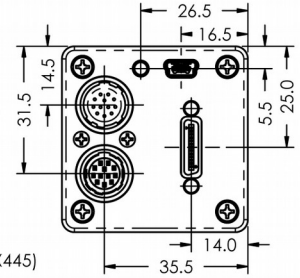

CoaXPress

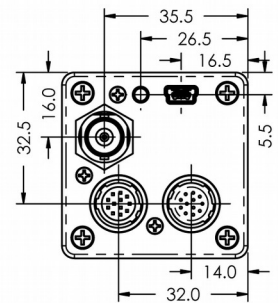
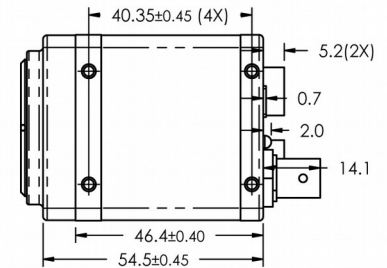

Hirose Connectors

Power and I/O Interface



- | | |
|-------------------|-----------------|
| 1 12V DC Return * | 7 OUT1 Signal |
| 2 +12V DC* | 8 IN1 Signal |
| 3 IRIS VCC | 9 IN2 Signal |
| 4 IRIS Video | 10 IN1/2 Return |
| 5 IRIS Return | 11 Reserved |
| 6 OUT1/2 Return | 12 OUT2 Signal |

*Not connected for CXP

Connector: Hirose HR 10A- 10R- 12PB(71)

Lens Control/RS232

See manual for PIN information

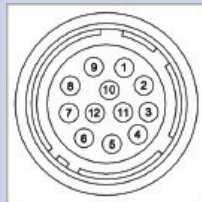

- | | |
|---------------|-------------|
| 1 IRIS Return | 7 FOCUS + |
| 2 IRIS VCC | 8 ZOOM - |
| 3 IRIS Video | 9 ZOOM + |
| 4 IRIS - | 10 UART_COM |
| 5 IRIS + | 11 UART_RX |
| 6 FOCUS - | 12 UART_TX |

Connector: Hirose HR 10A- 10R- 12SB(71)

B1310 Ordering Information

Interfaces available

- Camera Link® Base (CLB)
- GigE Vision (GEV / PoE)
- CoaXPress (CXP)

Sensor types available

- Monochrome
- Bayer Color

Accessories (Sold separately)

- PS12v04-Power Supply w/ 1 input and 1 output
- PS12v05-Power Supply (as above) and Video Iris



WWW.SACASA.INFO

Quality Management System ISO 9001:2008 Registered
 Environmental Management System ISO 14001:2004 Registered
 DDTC Registered (Directorate of Defense Trade Controls, US Department of State)

