

DT9826 Series

Portable, Simultaneous, Multifunction USB Data Acquisition Module

The DT9826 is a high-performance, multifunction data acquisition (DAQ) module for USB. The DT9826 features 16 simultaneous analog inputs, 16 digital input/output lines, 2 counter/timers, and a tachometer channel on a single plug-and-play device. Available as a board-level OEM version for embedded test applications, or installed in a metal BNC connection box for easy sensor connections.

Key Features:

- 16 Simultaneous, 24-bit Delta-Sigma A/D channels with $\pm 10V$ input range
- Sampling rates up to 41.6 kS/s per channel
- Simultaneous subsystem operation: analog input, digital I/O, counter/timer, and tachometer
- 16 DIO, two 32-bit C/ T channels, 1 Tach
- $\pm 500V$ galvanic isolation...prevent ground loops
- Board-level only OEM version available
- Compatible with LabVIEW and MATLAB
- Includes free QuickDAQ software...get up and running quickly
- Bus-powered for portability



Figure 1. Portable measurements can now be made with 4, 8, or 16 individual A/D channels. Each 24-bit sigma-delta A/D runs in parallel to prevent interference between channels. The DT9826 is fully featured with DIO, 32-bit C/Ts, tachometer, and multi-trigger modes. Software options abound to accommodate any environment. Available in BNC box or as embedded board-level OEM version.

Analog Input Channels

The DT9826 supports 16 single-ended analog inputs. Each channel features its own 24-bit A/D converter, with sampling rates up to 41.6 kSamples/second. Using the DT9826 module, data can be acquired from a single analog input channel or from a group of analog input channels using the analog input channel list.

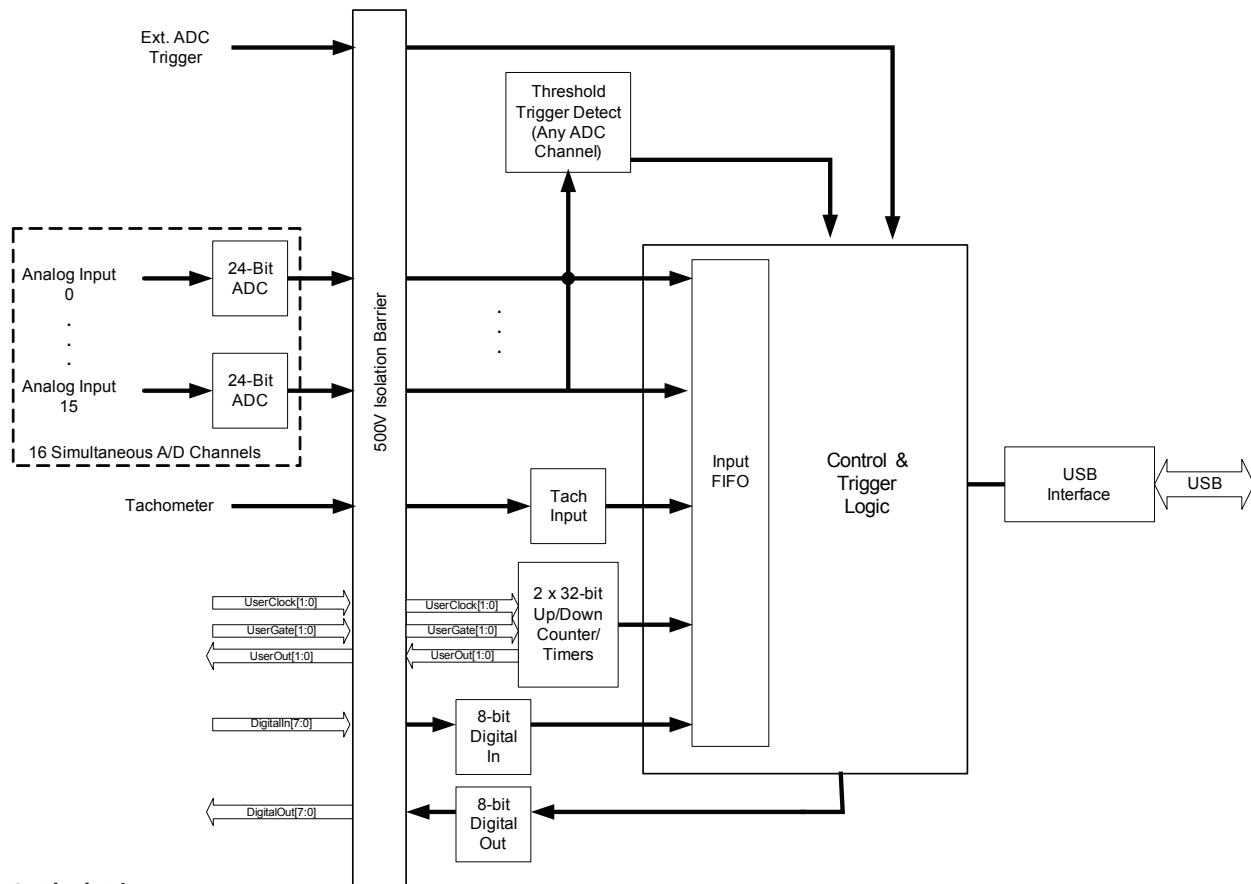

Figure 2. Block Diagram.

High Density, Simultaneous USB

DT9826 is designed on an 8-layer board, using both the front and back, to provide superior performance under all conditions. Particular emphasis on the layout is critical to this performance

Simultaneous Analog Inputs...

4, 8, or 16 Individual 24-bit sigma-delta A/D per channel

Ultra Digital I/O...

8 digital input lines & 8 digital output lines with flexibility for time stamping, pattern recognition, and synchronizing with external events

Full-featured Counter/Timers...

Two 32-bit C/T channels for counting events, up/down, edge-to-edge, discrete or continuous, pulse output... ideal for testing apps

Synchronous 32-bit tachometer input channel...

Reads rotation values of period or frequency synchronously with analog input measurements

Multi-trigger modes...

Software, external, or analog threshold trigger available as trigger sources

DC-DC Converters provide internal analog voltages...

Provide power to buffers

Fully protected...

±500V galvanic isolation protects your PC and maintains signal integrity, breakdown gap in etch

Signal conditioning and ESD protection...

Thin film resistors, capacitors, diode clamping provide scaling to high impedance buffers

Analog isolation barrier...

Serial data from 16 A/D channels

High-Speed USB 2.0...

USB 2.0 connector for data transfer at 480Mbps, optional pin substitute for embedded OEM use

Flexible Power Connections...

Portable operation for full specifications, optional +5V connection for secondary use when desired

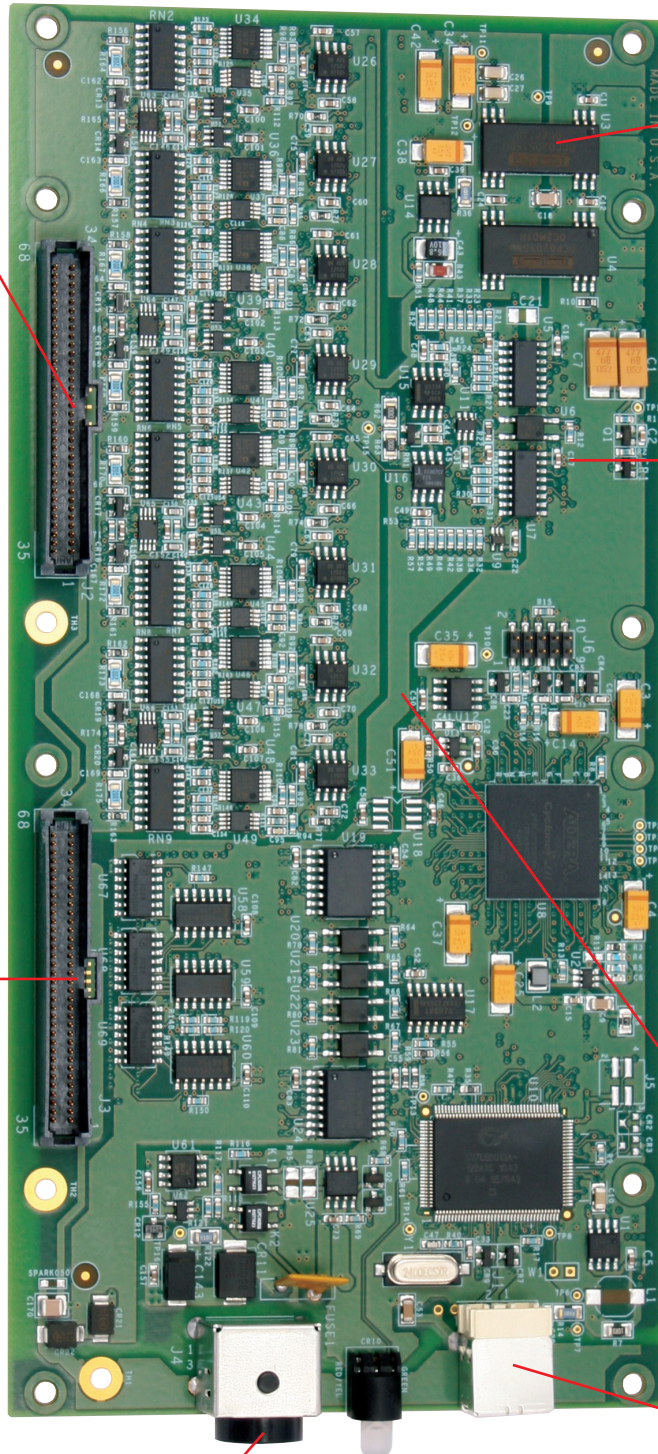

Analog Input Conversion Modes

The DT9826 module supports the following conversion modes:

- Single-Value Mode
- Continuous Scan Mode

Input Sample Clock Sources

The DT9826 module provides an internal A/D clock source for pacing analog input operations. The input sample clock also paces the acquisition of the digital input port, counter/timers, and tachometer if specified in the analog input channel list.

Input Triggers

A trigger is an event that occurs based on a specified set of conditions. On the DT9826, a start trigger and reference trigger can be specified. Pre-trigger acquisition starts when the module detects the start trigger event. When the reference trigger occurs, pre-trigger acquisition stops.

The DT9826 module supports the following trigger sources:

- Software trigger (for the start trigger)
- External digital (TTL) trigger (for the start trigger)
- Analog threshold trigger

Data Transfer

Before acquisition begins, buffers must be allocated to hold the data. An event is raised whenever a buffer is filled allowing data to be moved and/or processed as needed. Data is written to multiple allocated input buffers continuously; when no more empty buffers are available, the operation stops. The data is gap-free.

Tachometer Input Features

The DT9826 module supports a tachometer signal with a range of $\pm 30V$. This signal has a maximum frequency of 1 MHz and minimum pulse width of 0.4 μs . The threshold voltage is fixed at +2V with 0.5V of hysteresis.

The software automatically synchronizes the value of the tachometer input with the analog input measurements, so that all measurements are correlated in time. The tachometer input is treated like any other channel in the analog input channel list; therefore, all the triggering and conversion modes supported for analog input channels are supported for the tachometer input.

Digital I/O Lines

DT9826 modules support one digital input port, consisting of 8 digital input lines, and one digital output port, consisting of 8 digital output lines. The resolution is fixed at 8-bits. A digital line is high if its value is 1; a digital line is low if its value is 0. On power up or reset, a low value (0) is output from each of the digital output lines.

The DT9826 module supports the following digital I/O operation modes:

- Single-value operations
- Continuous digital input

Counter/Timer Channels

The DT9826 modules provide two 32-bit counter/timers. Each counter accepts a clock input signal and gate input signal and outputs a pulse (pulse output signal). Using software, one or both of the counter/timers can be specified in the analog input channel list (as channels 17 and 18).

Counter/Timer Operation Modes

DT9826 modules support numerous counter/timer operation modes, including event counting, up/down counting, frequency measurement, edge-to-edge measurement, continuous edge-to-edge measurement, rate generation, one-shot, and repetitive one-shot.

Counter/Timer Clock Sources

The following clock sources are available for the counter/timers:

- Internal C/T clock
- External C/T clock

Gate Types

The edge or level of the Counter n Gate signal determines when a counter/timer operation is enabled.

The DT9826 module supports the following gate types:

- None
- Logic-low level external gate input
- Logic-high level external gate input
- Falling-edge external gate input
- Rising-edge external gate input

Pulse Output Types and Duty Cycles

The DT9826 modules can output the following types of pulses from each counter/timer:

- High-to-low transitions
- Low-to-high transitions

The pulse output type is specified in software.

The duty cycle (or pulse width) indicates the percentage of the total pulse output period that is active.

QuickDAQ

QuickDAQ allows you to acquire and display from all Data Translation USB and Ethernet data acquisition devices that support analog input streaming. Combine QuickDAQ with Data Translation hardware to acquire data, record data to disk, display the results in both a plot and digital display, and read a recorded data file. Be productive right out of the box with this powerful data logging software. Data can be exported to other applications like Microsoft Excel® and The Mathworks MATLAB® for more advanced analysis. Two additional options can be purchased to add FFT analysis capabilities to the base package.

Key Features:

- **QuickDAQ Base Package (Free)**
 - Ready-to-measure application software
 - Configure, acquire, log, display, and analyze your data
 - Customize many aspects of the acquisition, display, and recording functions to suit your needs
- **FFT Analysis Option (License Required)**
 - Includes all the features of the QuickDAQ Base Package
 - Perform single-channel FFT operations including:
 - ◆ Auto Spectrum
 - ◆ Spectrum
 - ◆ Power Spectral Density
 - Configure and view dynamic performance statistics
 - Supports Hanning, Hamming, Bartlett, Blackman, Blackman Harris, and Flat Top response windows
- **Advanced FFT Analysis Option (License Required)**
 - Includes all the features of the QuickDAQ Base Package and FFT Analysis Package
 - Perform 2-channel FFT operations including:
 - ◆ FRF
 - ◆ Cross-Spectrum
 - ◆ Cross Power Spectral Density
 - ◆ Coherence
 - ◆ Coherent Output Power
 - Supports real, imaginary, and Nyquist display functions
 - Additional FFT analysis functions supported: Exponential, Force, Cosiner Taper
 - Save data to .uff file format

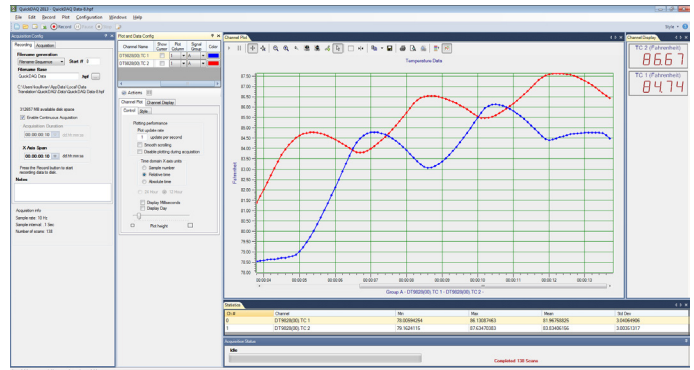

Figure 3: QuickDAQ ships free-of-charge and allows you to get up and running quickly.

Other Software Options

There are many software choices available for application development, from ready-to-measure applications to programming environments.

The following software is available for use with the DT9826 Series modules and is provided on the Data Acquisition Omni CD:

- **DT9826 Series Device Driver** –The device driver allows you to use a DT9826 Series module with any of the supported software packages or utilities.
- **DT9826 Series Calibration Utility** – This utility allows you to calibrate features of a DT9826 Series module.
- **Quick DataAcq** application – The Quick DataAcq application provides a quick way to get up and running. Using this application, verify key features of the module, display data on the screen, and save data to disk.
- **DT-Open Layers® for .NET Class Library** – Use this class library if you want to use Visual C#® or Visual Basic® for .NET to develop application software using Visual Studio® 2003-2012; the class library complies with the DT-Open Layers standard.
- **DataAcq SDK** – Use the Data Acq SDK to use Visual Studio 6.0 and Microsoft® C or C++ to develop application software using Windows® XP/Vista/7/8; the DataAcq SDK complies with the DT-Open Layers standard.
- **DAQ Adaptor for MATLAB** – Data Translation’s DAQ Adaptor provides an interface between the MATLAB® Data Acquisition (DAQ) toolbox from The MathWorks™ and Data Translation’s DT-Open Layers architecture.
- **LV-Link** – Data Translation’s LV-Link is a library of VIs that enable LabVIEW™ programmers to access the data acquisition features of DT-Open Layers compliant USB and PCI devices.

Making Dynamic Measurements (FIGURES 4a-4f)

The FFT plots show the dynamic performance of the DT9826. Many users believe that a 24-bit A/D system will give 24 bit accuracy or at least close to that accuracy. But when measuring a dynamic signal, i.e. with frequency components above DC, other factors degrade the measurement in attaining that 24 bit accuracy. Noise and harmonic distortion are key factors to degrading accuracy. Also phase shift becomes an issue at low bandwidths.

But it isn't just the circuitry. Layout of the critical circuit etch, spacing between noise-generating and noise-sensitive devices as well as analog and digital etch patterns, and thermal effects from one circuit to another are all culprits in degrading accuracy.

Therefore, DC specifications are useful, and plots in Fig 4(a) and 4(b) yield the best ENOB figures of merit at 16 bit accuracy from all errors at operating throughputs of 40kHz and 20kHz. But this is with zero signal level.

But dynamic FFT plots at higher input voltage, and maximum operating frequency give the best indicator of accuracy. Fig 4(c) and 4(d) show results at 1/2 full scale (-6dB) and yield good results at approximately 15 bits ENOB (Effective Number of Bits) performance.

Now worst case is Fig 4(e) and 4(f) showing maximum signal level of ±10V and sample rates of 40kHz and 20kHz. The ENOB plot shows 14.3, rather than the full 24-bit accuracy. This number is actually outstanding and has been attained through careful design with many years of experience.

So conditions of use really determine the accuracy for dynamic measurements. The ENOB number can be higher (Fig 4a-d) if less than full scale is used (e.g. 1/2 scale), but this would give a misleading picture for many users.

Download the ENOB white paper: <http://www.datatranslation.com/ENOBPAPER/>

IBF = Input Below Full Scale. Specified in dB, represents how far the input sine wave is below the full-scale capability of the A/D.

S/(N+D) = Signal to Noise plus Distortion (also represented as SINAD). Specified in dB, it is the ratio of the signal to the sum of all noise and distortion components.

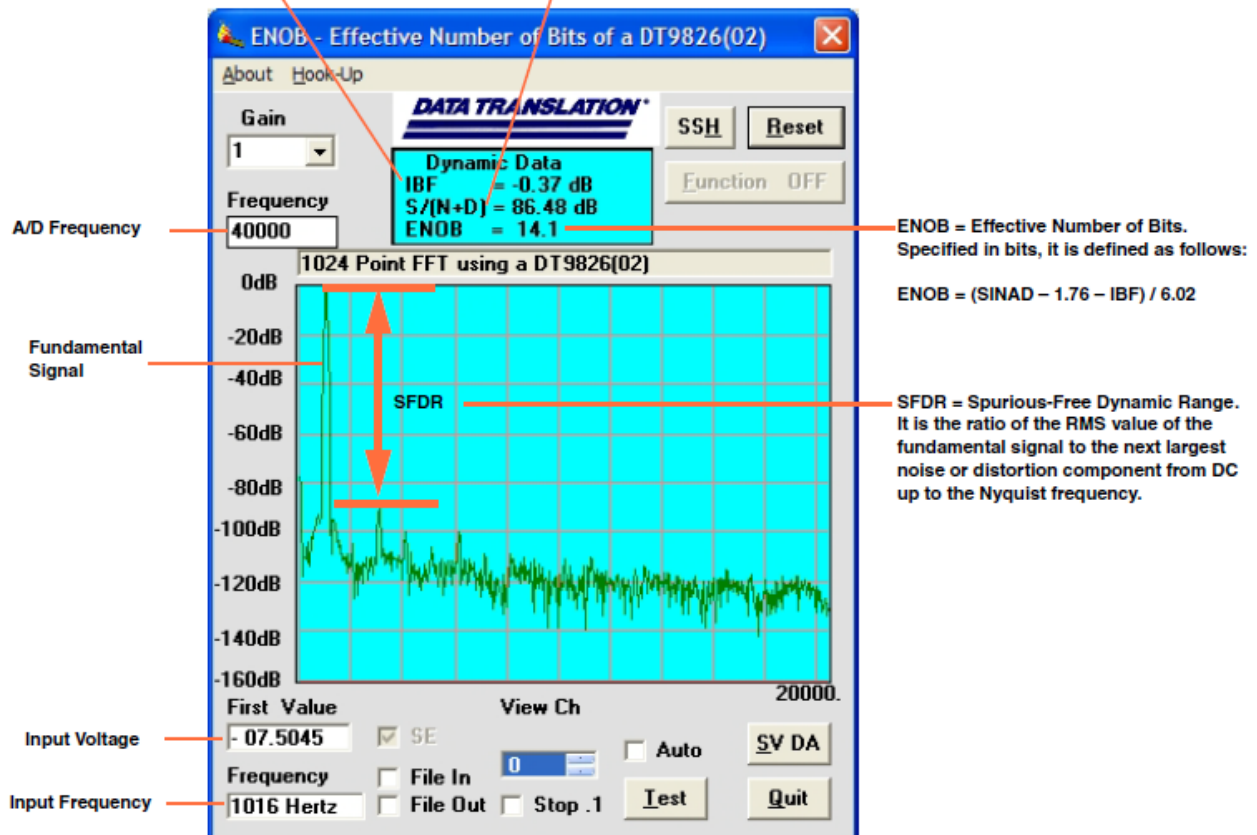

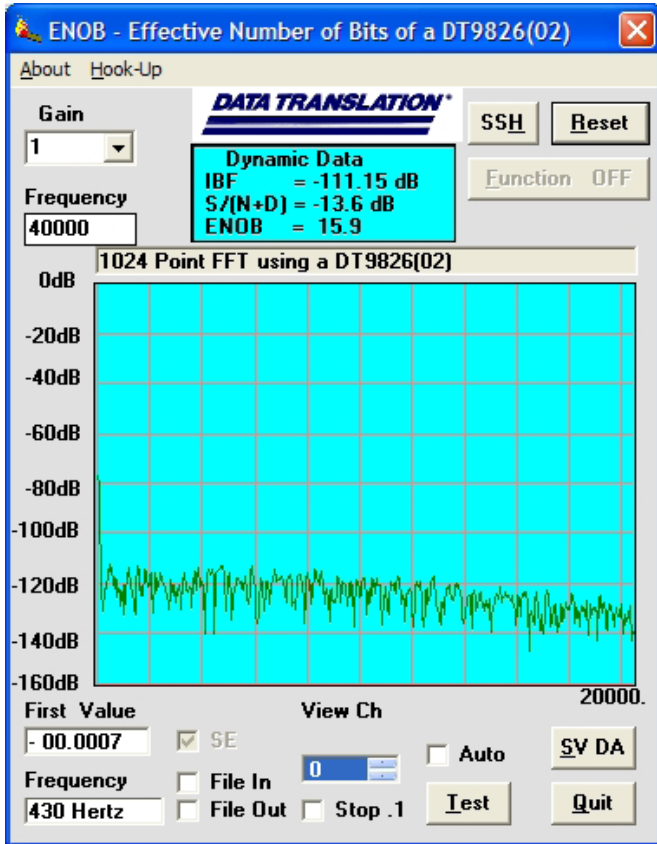

Figure 4(a). 0V input, 40kHz sampling rate.

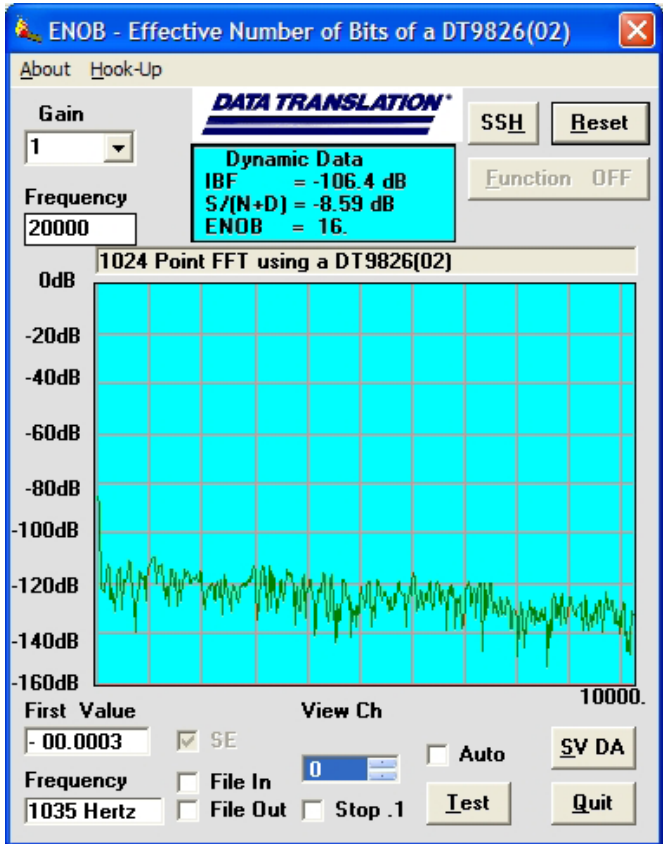

Figure 4(b). 0V input, 20kHz sampling rate.

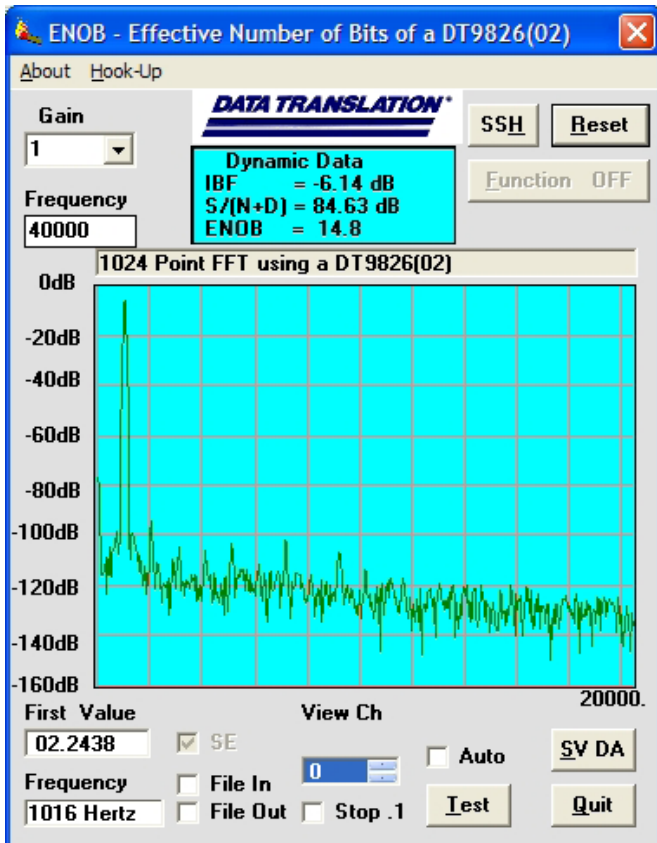

Figure 4(c). 1/2 full scale, 40kHz sampling rate.

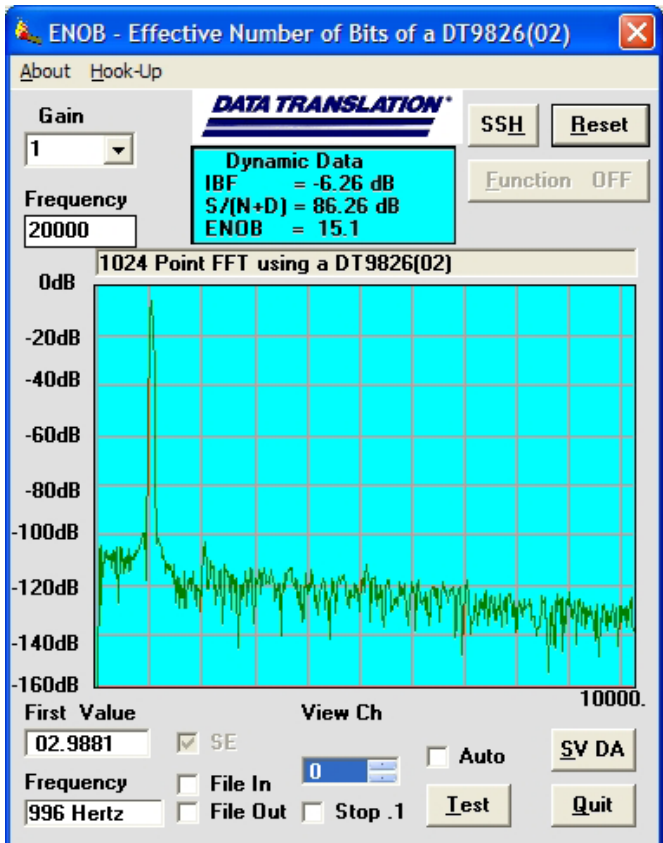

Figure 4(d). 1/2 full scale, 20kHz sampling rate.

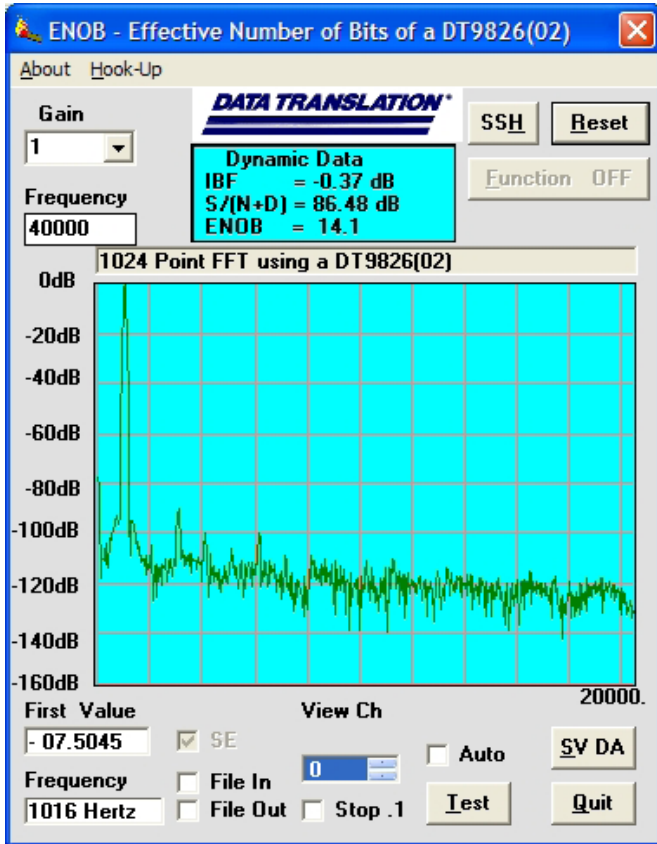

Figure 4(e). Full scale, 40kHz sampling rate.

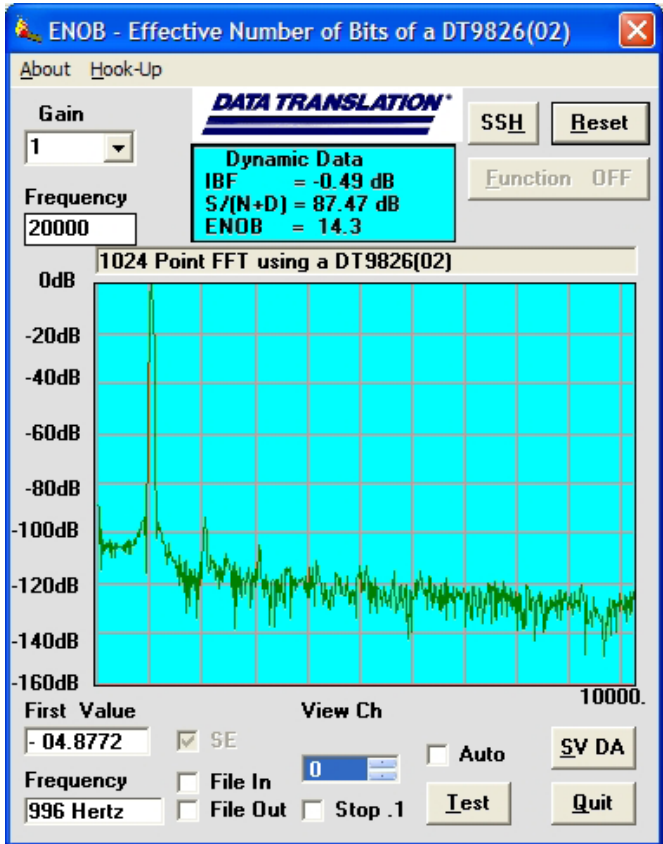

Figure 4(f). Full scale, 20kHz sampling rate.

±500V Galvanic Isolation Protects Your Data

Computers are susceptible to ground-spikes through any external port. These spikes can cause system crashes and may even cause permanent damage to the computer. The DT9826 module features ±500 Volts of galvanic isolation to protect the computer from ground-spikes and to ensure a reliable stream of data.

Technical Support

Application engineers are available by phone and email during normal business hours to discuss your application requirements. Extensive product information, including drivers, example code, pinouts, a searchable Knowledge Base, and much more, is available 24 hours a day on our web site at www.datatranslation.com.

Accessories

The following optional accessories are available for use with the DT9826 module:

- **BNC DIN Rail Kit** — Kit for mounting USB modules in BNC enclosure to a DIN rail. Includes mounting clips, screws, and instructions. DIN Rail not included.
- **EP355** — This screw terminal panel provides a 14-position screw terminal block for attaching analog input, digital I/O, counter/timer, and clock signals. (For OEM configurations only.)



Figure 6. With the optional DIN rail mounting kit (BNC DIN RAIL KIT), you can mount the DT9826 BNC model to a standard DIN rail.

Ordering Summary

HARDWARE:

- DT9826
- DT9826-OEM

ACCESSORIES

- **BNC DIN Rail Kit** — Kit for mounting USB modules in BNC enclosure to a DIN rail. Includes mounting clips, screws, and instructions. DIN Rail not included.
- **EP355** — Screw terminal panel

FREE SOFTWARE

- **QuickDAQ**
- **DAQ Adaptor for MATLAB** — Access the analysis and visualization tools of MATLAB®.
- **LV-Link** — Access the power of Data Translation boards through LabVIEW™.

OPTIONAL SOFTWARE

- **QuickDAQ FFT Analysis Option** (License Required)
- **QuickDAQ Advanced FFT Analysis Option** (License Required)